

Earphone Specification

Part No.	PED 1585/100
Type:	Mylar, moving coil
Size:	Ø 40.6mm ±0.25mm
Impedance:	100Ω ±15%
Typical Output Level:	116dB SPL ±3dB @ 1KHz 1mW on IEC-318 ear
Nominal Input:	50mW
Maximum Input	100mW
Ingress Protection	IP67

Outline:

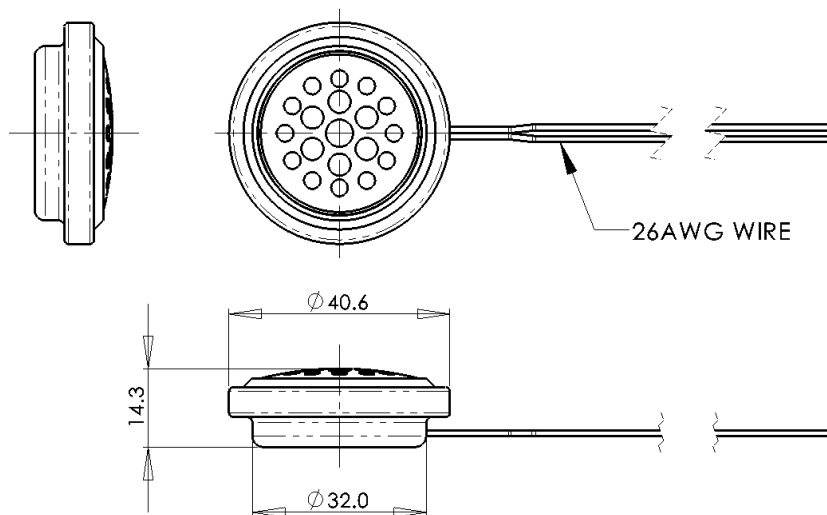

Typical Freq Response:

