

Earphone Specification

Part No.	PED 1580/600
Type:	Mylar, moving coil
Size:	Ø 40.6mm ±0.25mm
Impedance:	600Ω ±15%
Typical Output Level:	125dB SPL ±3dB @ 1KHz 1mW on IEC-318 ear
Nominal Input:	30mW
Maximum Input	100mW
Ingress Protection	IP67

Outline:

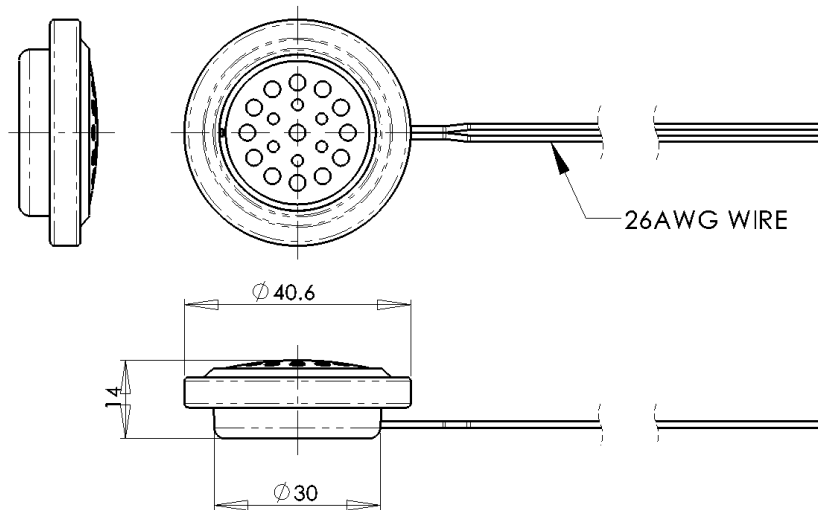

Typical Freq Response:

